



DVD PLAYER

203G USB



**DVD, MPEG-4
INX, INX2, Super CD+G
CD+Graphics**

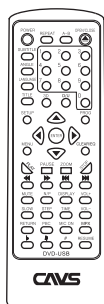

Digital Direct Progressive Scan

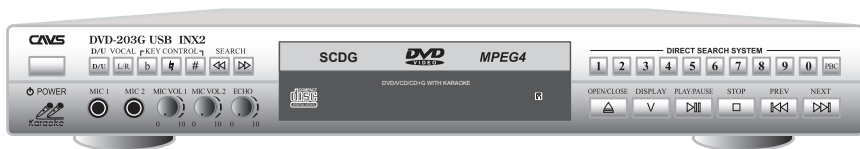

INSTRUCTIONS

Before operation	2
Preparations	5
Basic operations	7
Advanced operations	10
Karaoke operations	13
Audio/Video files playback	15
USB memory device operations	17
Changing the initial settings	20
Additional information	24

For Customer Use:

Enter below the Model No. and Serial No. which are located on the rear, bottom or side of the cabinet. Retain this information for future reference.

Model No. _____

Serial No. _____

Warnings, Cautions and Others

Mises en garde, précautions et indications diverses

CAUTION

RISK OF ELECTRIC SHOCK
DO NOT OPEN

CAUTION: TO REDUCE THE RISK OF ELECTRIC SHOCK. DO NOT REMOVE COVER (OR BACK) NO USER SERVICEABLE PARTS INSIDE. REFER SERVICING TO QUALIFIED SERVICE PERSONNEL.



The lightning flash with arrowhead symbol, within an equilateral triangle is intended to alert the user to the presence of uninsulated "dangerous voltage" within the product's enclosure that may be of sufficient magnitude to constitute a risk of electric shock to persons.



The exclamation point within an equilateral triangle is intended to alert the user to the presence of important operating and maintenance (servicing) instructions in the literature accompanying the appliance.

For U.S.A.

This equipment has been tested and found to comply with the limits for a Class B digital device, pursuant to part 15 of the FCC Rules. These limits are designed to provide reasonable protection against harmful interference in a residential installation.

This equipment generates, uses and can radiate radio frequency energy and, if not installed and used in accordance with the instructions, may cause harmful interference to radio communications. However, there is no guarantee that interference will not occur in a particular installation. If this equipment does cause harmful interference to radio or television reception, which can be determined by turning the equipment off and on, the user is encouraged to try to correct the interference by one or more of the following measures:

- Reorient or relocate the receiving antenna.
- Increase the separation between the equipment and receiver.
- Connect the equipment into an outlet on a circuit different from that to which the receiver is connected. Consult the dealer or an experienced radio/TV technician for help.

WARNING: TO REDUCE THE RISK OF FIRE OR ELECTRIC SHOCK, DO NOT EXPOSE THIS APPLIANCE TO RAIN OR MOISTURE.

For Canada/Pour le Canada

CAUTION: TO PREVENT ELECTRIC SHOCK, MATCH WIDE BLADE OF PLUG TO WIDE SLOT, FULLY INSERT
ATTENTION: POUR EVITER LES CHOCS ELECTRIQUES, INTRODUIRE LA LAME LA PLUS LARGE DE LA FICHE DANS LA BORNE CORRESPONDANTE DE LA PRISE ET POUSSER JUSQU'AU FOND

For Canada/Pour le Canada

THIS DIGITAL APPARATUS DOES NOT EXCEED THE CLASS B LIMITS FOR RADIO NOISE EMISSIONS FORM DIGITAL APPARATUS AS SET OUT IN THE INTERFERENCE-CAUSING EQUIPMENT STANDARD ENTITLED "DIGITAL APPARATUS," ICES-003 OF THE DEPARTMENT OF COMMUNICATIONS. CET APPAREIL NUMERIQUE RESPECTE LES LIMITES DE BRUITS RADIO ELECTRIQUES APPLICABLES AUX APPAREILS NUMERIQUES DE CLASSE B PRESCRITES DANS LA NORMESUR LE MATERIEL BROUILLEUR: "APPAREILS NUMERIQUES", NMB-003 EDICTEE PAR LE MINISTRE DES COMMUNICATIONS.

CAUTION

- To reduce the risk of electrical shocks, fire, etc.:
1. Do not remove screws, covers or cabinet.
 2. Do not expose this appliance to rain or moisture.

ATTENTION

- Afin d'éviter tout risque d'électrocution, d'incendie, etc.:
1. Ne pas enlever les vis ni les panneaux et ne pas ouvrir le coffret de l'appareil.
 2. Ne pas exposer l'appareil à la pluie ni à l'humidité.

Caution - STANDBY/ON

Disconnect the mains plug to shut the power off completely. The POWER button on the remote control does not disconnect the mains line when the POWER button on the front panel is pressed in.

- * When the player is on standby, the POWER button is pressed in.
- * When the player is on standby, the power can be controled by remote control.

IMPORTANT FOR LASER PRODUCTS IMPORTANT POUR LES PRODUITS LASER

1. CLASS 1 LASER PRODUCT
2. **CAUTION :** Do not open the top cover. There are no user serviceable parts inside the unit; leave all servicing to qualified service personnel.
3. **CAUTION :** Visible and invisible laser radiation when open and interlock failed or defeated. Avoid direct exposure to beam.
4. REPRODUCTION OF LABEL : CAUTION LABEL, PLACED INSIDE THE UNIT.
1. PRODUIT LASER CLASSE 1
2. **ATTENTION :** N'ouvrez pas le couvercle supérieur. Il n'y aucune pièce réparable par l'utilisateur à l'intérieur de l'appareil; confiez toute réparation à un personnel qualifié.
3. **ATTENTION :** Risque de radiations laser visible et invisible quand l'appareil est ouvert ou que le système de verrouillage ne fonctionne pas ou a été mis hors service. Évitez toute exposition directe au rayon.
4. REPRODUCTION DE L'ÉTIQUETTE : ÉT QUETTE CE PRÉCAUTION PLACÉE L'INTERIEUR DE L'APPAREIL.

<p>CAUTION: Visible and invisible laser radiation when open and interlock failed or defeated. AVOID DIRECT EXPOSURE TO BEAM. (e)</p>	<p>ADVARSEL: Synlig og usynlig laserstråling når maskinen er åben eller interlocken fejler. Undgå direkte eksponering til stråling. (d)</p>	<p>VARNING: Synlig och osynlig laserstråling när den öppnas och spårren är urkopplad. Betrakta ej strålen. (s)</p>	<p>VARO: Avattaessa ja suojalukitus ohitettuna tai viallisena olet alttiina näkyvälle ja näkymättömälle lasersäteilylle. Valta säteen kohdistumista suoraan itseesi. (f)</p>
---	--	---	---

CAUTION :

- * Do not block the ventilation openings or holes. (If the ventilation openings or holes are blocked by a newspaper or cloth, etc., the heat may not be able to get out.)
- * Do not place any naked flame sources, such as lighted candles, on the apparatus.
- * When discarding batteries, environmental problems must be considered and local rules or laws governing the disposal of these batteries must be followed strictly.
- * Do not expose this apparatus to rain, moisture, dripping or splashing and that no objects filled with liquids, such as vases, shall be placed on the apparatus.

ATTENTION :

- * Ne bloquez pas les orifices ou les trous de ventilation. (Si les orifices ou les trous de ventilation sont bloqués par un journal un tissu, etc., la chaleur peut ne pas être évacuée correctement de l'appareil.)
- * Ne placez aucune source de flamme nue, telle qu'une bougie, sur l'appareil.
- * Lors de la mise au rebut des piles, veuillez prendre en considération les problèmes de l'environnement et suivre strictement les règles et les lois locales sur la mise au rebut des piles.
- * N'exposez pas cet appareil à la pluie, à l'humidité, à un égouttement ou à des éclaboussures et ne placez pas des objets remplis de liquide, tels qu'un vase, sur l'appareil.

Important Product Safety Instruction

Electrical energy can perform many useful functions. But improper use can result in potential electrical shock or fire hazards. This product has been engineered and manufactured to assure your personal safety. In order not to defeat the built-in safeguards, observe the following basic rules for its installation, use and servicing.

ATTENTION: Follow and obey all warnings and instructions marked on your product and its operating instructions. For your safety, please read all the safety and operating instructions before you operate this product and keep this brochure and the operating instructions packaged with your product for future reference.

INSTALLATION

1. Grounding or Polarization

- (A) Your product may be equipped with a polarized alternating-current line plug (a plug having one blade wider than the other). This plug will fit into the power outlet only one way. This is a safety feature. If you are unable to insert the plug fully into the outlet, try reversing the plug. If the plug should still fail to fit, contact your electrician to replace your obsolete outlet. Do not defeat the safety purpose of the polarized plug.
- (B) Your product may be equipped with a 3-wire grounding-type plug, a plug having a third (grounding) pin. This plug will only fit into a grounding-type power outlet. This is a safety feature. If you are unable to insert the plug into the outlet, contact your electrician to replace your obsolete outlet. Do not defeat the safety purpose of the grounding-type plug.

2. Power Sources

Operate your product only from the type of power source indicated on the marking label. If you are not sure of the type of power supply to your home, consult your product dealer or local power company. If your product is intended to operate from battery power, or other sources, refer to the operating instructions.

3. Overloading

Do not overload wall outlets, extension cords, or integral convenience receptacles as this can result in a risk of fire or electric shock.

4. Power Cord Protection

Power supply cords should be routed so that they are not likely to be walked on or pinched by items placed upon or against them, paying particular attention to cords at plugs, convenience receptacles, and the point where they exit from the product.

5. Ventilation

Slots and openings in the cabinet are provided for ventilation. To ensure reliable operation of the product and to protect it from overheating, these openings must not be blocked or covered.

- * Do not block the openings by placing the product on a bed, sofa, rug or other similar surface.
- * Do not place the product in a built-in installation such as a bookcase or rack unless proper ventilation is provided or the manufacturer's instructions have been adhered to.

6. Wall or Ceiling Mounting

The product should be mounted to wall or ceiling only as recommended by the manufacturer.

ANTENNA INSTALLATION INSTRUCTIONS

1. Outdoor Antenna Grounding

If an outside antenna or cable system is connected to the product, be sure the antenna or cable system is grounded so as to provide some protection against voltage surges and built-up static charges. Article 810 of the National Electrical Code, ANSI/NFPA 70, provides information with regard to proper grounding of the mast and supporting structure, grounding of the lead-in wire to an antenna discharge unit, size of grounding conductors, location of antenna discharge unit, connection to grounding electrodes, and requirements for the grounding electrode.

2. Lightning

For added protection for this product during a lightning storm, or when it is left unattended and unused for long periods of time, unplug it from the wall outlet and disconnect the antenna or cable system. This will prevent damage to the product due to lightning and power-line surges.

3. Power Lines

An outside antenna system should not be located in the vicinity of overhead power lines or other electric light or power circuits, or where it can fall into such power lines or circuits. When installing an outside antenna system, extreme care should be taken to keep from touching such power lines or circuits as contact with them might be fatal.

USE

1. Accessories

- * Do not place this product on an unstable cart, stand, tripod, bracket, or table. It may fall, causing serious injury to a child or adult, and serious damage to the product.
- * Use only with a cart, stand, tripod, bracket, or table recommended by the manufacturer or sold with the product.
- * Use a mounting accessory recommended by the manufacturer and follow the manufacturer's instructions for any mounting of the product.
- * Do not try to roll a cart with small casters across thresholds or deep-pile carpets.

2. Product and Cart Combination

A product and cart combination should be moved with care, Quick stops, excessive force, and uneven surfaces may cause the product and cart combination to overturn.



PORTABLE CART WARNING
(Symbol provided by RETAC)

3. Water and Moisture

Do not use this product near water-for example, near a bath tub, wash bowl, kitchen sink or laundry tub, in a wet basement, or near a swimming pool and the like.

4. Object and Liquid Entry

Never push objects of any kind into this product through openings as they may touch dangerous voltage point or short-out parts that could result in a fire or electric shock. Never spill liquid of any kind on the product.

5. Attachments

Do not use attachments not recommended by the manufacturer of this product as they may cause hazards.

6. Cleaning

Unplug this product from the wall outlet before cleaning. Do not use liquid cleaners or aerosol cleaners. Use a damp cloth for cleaning.

7. Heat

The product should be situated away from heat sources such as radiators, heat registers, stoves, or other products (including amplifiers) that produce heat.

SERVICING

1. Servicing

If your product is not operating correctly or exhibits a marked change in performance and you are unable to restore normal operation by following the detailed procedure in its operating instructions, do not attempt to service it yourself as opening or removing covers may expose you to dangerous voltage or other hazards. Refer all servicing to qualified service personnel.

2. Damage Requiring Service

Unplug this product from the wall outlet and refer servicing to qualified service personnel under the following conditions:

- When the power supply cord or plug is damaged.
- If liquid has been spilled, or objects have fallen into the product.
- If the product has been exposed to rain or water.
- If the product does not operate normally by following the operating instructions. Adjust only those controls that are covered by the operating instructions as an improper adjustment of other controls may result in damage and will often require extensive work by a qualified technician to restore the product to its normal operation.
- If the product has been dropped or damaged in any way.
- When the product exhibits a distinct change in performance-this indicates a need for service.

3. Replacement Parts

When replacement parts are required, be sure the service technician has used replacement parts specified by the manufacturer or have the same characteristics as the original part. Unauthorized substitutions may result in fire, electric shock or other hazards.

4. Safety Check

Upon completion of any service or repairs to this product, ask the service technician to perform safety checks to determine that the product is in safe operating conditions.



Supplied accessories

Check that you have all the following accessories supplied to you. If anything is missing, consult your dealer immediately.

- * Audio/video cable (Yellow/White/Red)
- * Remote control unit
- * R6(SUM-3)/AA(15F) battery x 2
- * AC power plug adaptor
- * USB cable
- * User's Manual

About this manual

- * The display window information and OSD (On Screen Display) menu items are put in CAPITAL letters in the operation procedures.
- * Usable disc(s) for each operation/function is (are) referred to by the icons;



Precautions

Notes on the power cord

- * When you are away on travel or otherwise for an extended period of time, remove the plug from the wall outlet.
- * When unplugging the player from the wall outlet, always pull the plug, not the power cord.
- * Do not handle the power cord with wet hands!

Avoid moisture, water and dust

- * Do not place the player in moist or dusty places.
- * If water gets inside the player, turn off the power and remove the plug from the wall outlet, then consult your dealer. Using the player in this state may cause a fire or electrical shock.

Avoid high temperatures

- * Do not expose the player to direct sunlight or place it near a heating device.

Notes on installation

- * Select a place which is level, dry and neither too hot nor too cold.
- * Leave sufficient distance between the player and the TV.
- * Do not install the player in a place subject to vibrations.
- * Do not put heavy objects on the player.

To prevent malfunction of the player

- * There are no user-serviceable parts inside. If anything goes wrong, unplug the power cord and consult your dealer.
- * Do not insert any metallic objects, such as wires, hairpins, coins, etc. into the player.
- * Do not block the vents. Blocking the vents may damage the player.

To clean the cabinet

- * Use a soft cloth. Follow the relevant instructions on the use of chemically-coated cloths.
- * Do not use benzene, thinner or other organic solvents and disinfectants. These may cause deformation or discoloring.

Table of contents

Before operation 2

About playable media	2
Care and handling of discs	2
Names of parts and controls	3

Preparations 5

Connections	5
Using the remote control unit	6

Basic operations 7

Turning on/off the player	7
Initial setup	7
Basic playback	8
Various speed playback	9
Locating the beginning of a scene or song	9

Advanced operations10

Playing from a specific position	10
Changing the playback order	11
Repeat playback	11
Changing the language, sound and scene angle	11
Special picture/sound effect	12

Karaoke operations13

Karaoke operations	13
--------------------------	----

Audio/Video files playback15

Outline	15
Basic operations	16

USB memory device operations17

Outline	17
Basic operations	18

Changing the initial settings20

Selecting preferences	20
Selecting general setup	21
Selecting speaker setup	22
Selecting audio setup	22
Selecting karaoke setup	23
Selecting equalizer	23

Additional information24

Troubleshooting	24
Specifications	24

Before operation

About playable media

Optical discs

Disc types:
DVD, MPEG-4, Video CD, Super CD+G, INX, INX2,
CD+Graphics, Audio CD, HDCD

File types:
AVI, MP3, JPEG

Media types:
DVD±R, DVD±R DL, DVD-RW, CD-R, CD-RW

USB memory devices

File types:
AVI, CD+G (MP3+MCG), CD+G (MP3G), MP3, JPEG

Media types:
External hard drive (FAT32), Memory stick (FAT32)

NOTE

If a disc gets dirty, scratched or warped, or due to the disc characteristics or recording conditions, it may take considerable time for the player to read the content, or the player may not be able to playback such discs.

Color system format

This player accommodates both the NTSC and PAL systems, and also can play back discs recorded with NTSC and PAL system.

Digital audio formats

The player supports the following digital audio formats:
Linear PCM, Dolby Digital 5.1 Channels, DTS

NOTE

Depending on the player's AUDIO SETUP - SPDIF setting, digital audio signals may not be output as they are recorded on the disc.

Notes on discs

- * With some DVD VIDEO discs, the player starts playback automatically after inserting the disc.
- * The image may be sometimes poor or noisy due to defects in the disc itself.
- * With some discs, operations described in this manual may not be possible.

Care and handling of discs

If a disc gets dirty, dusty, scratched or warped, playback sound and picture may be deteriorated. Take proper precautions when handling discs.

Handling

- * Do not touch the surface of the disc.
- * Do not damage, stick paper to, or use any adhesive on either the label side or playback side.



Storing discs

- * Keep discs in their cases. If discs are piled on top of one another without their protective cases, they can be damaged.
- * Do not put discs in a location where they may be exposed to direct sunlight, or where the humidity or temperature is high.
Avoid leaving discs in a car!



Cleaning discs

- * Wipe with a soft dry cloth, moving from the center outwards. If a disc is difficult to clean, wipe with a cloth moistened with water.
- * Never use record cleaners, petrol, alcohol or any anti-static agents.



Before operation

Names of parts and controls

Front panel



- | | | | |
|------------------------|------------------------|-------------------------|--------------|
| ① Power button | ⑤ MIC 2 Volume Control | ⑨ KEY CONTROLS | ⑬ OPEN/CLOSE |
| ② MIC 1 Input Jack | ⑥ ECHO | ⑩ SEARCH | ⑭ DISPLAY |
| ③ MIC 2 Input Jack | ⑦ DISC/USB | ⑪ Numeric Buttons (0~9) | ⑮ PLAY/PAUSE |
| ④ MIC 1 Volume Control | ⑧ VOCAL | ⑫ PBC | ⑯ STOP |
| | | ⑬ OPEN/CLOSE | ⑰ PREV |
| | | | ⑱ NEXT |

Back panel

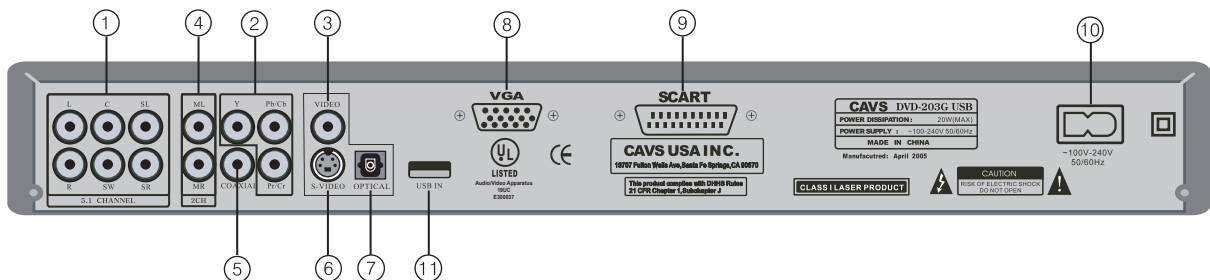

- | | |
|--|------------------------|
| ① Analog 5.1 Channel Dolby Audio Outputs | ⑥ S-Video Output |
| ② Component Video Outputs | ⑦ Optical Audio Output |
| ③ Composite Video Output | ⑧ VGA Video Output |
| ④ 2 Channel Downmix Audio Outputs | ⑨ Scart Video Output |
| ⑤ Coaxial Digital Audio Output | ⑩ Power Cord |
| | ⑪ USB IN |

Display window

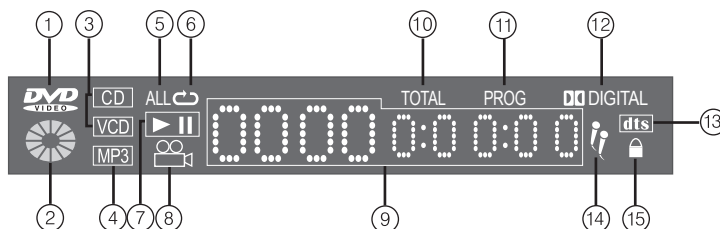

- | | |
|---|--------------------------------|
| ① DVD Video format indicator | ⑨ Multiple Information window |
| ② Playback indicator | ⑩ TOTAL Content indicator |
| ③ CD / VCD Video format indicator | ⑪ PROGRAM indicator |
| ④ MP3 Audio format indicator | ⑫ DOLBY Audio format indicator |
| ⑤ Repeat ALL indicator | ⑬ DTS Audio format indicator |
| ⑥ Repeat One indicator | ⑭ Karaoke Mode indicator |
| ⑦ Play / Pause indicator | ⑮ Parental Lock indicator |
| ⑧ Multiple Angle video format indicator | |

Before operation

Remote control unit

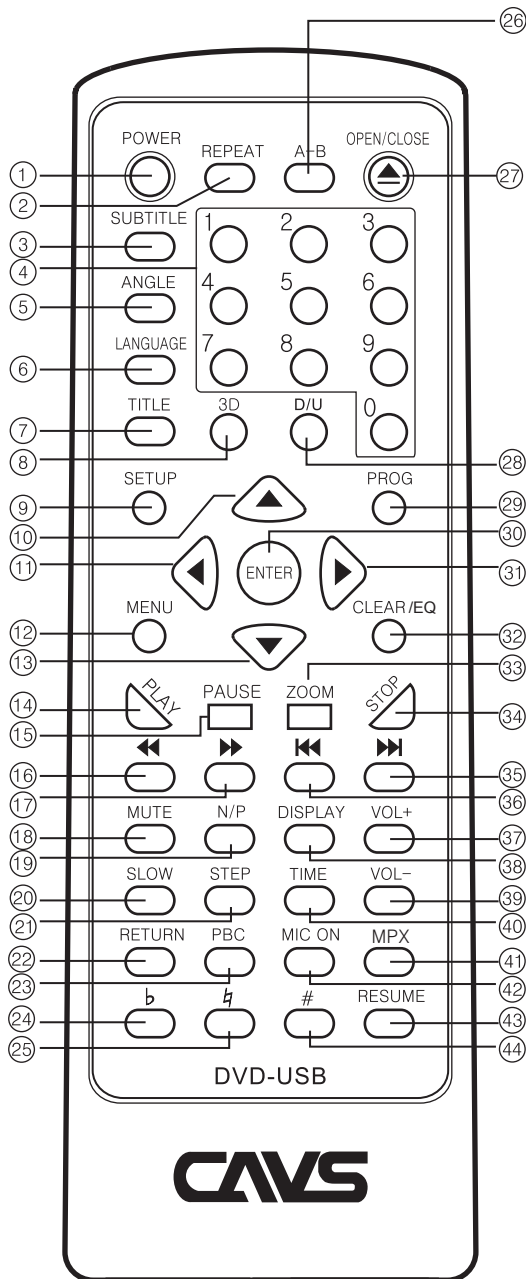

- ① POWER
- ② REPEAT
- ③ SUBTITLE
- ④ Numeric buttons
- ⑤ MULTI ANGLE
- ⑥ LANGUAGE (AUDIO)
- ⑦ TITLE
- ⑧ 3D
- ⑨ SETUP
- ⑩ ▲ UP
- ⑪ ◀ LEFT
- ⑫ MENU
- ⑬ ▼ DOWN
- ⑭ PLAY
- ⑮ PAUSE
- ⑯ ◀◀ FAST BACKWARD
- ⑰ ▶▶ FAST FORWARD
- ⑱ MUTE
- ⑲ NTSC/PAL
- ⑳ SLOW
- ㉑ STEP
- ㉒ RETURN
- ㉓ PBC
- ㉔ ♭ LOWER KEY (PITCH)
- ㉕ ♯ RESET KEY (PITCH)
- ㉖ A-B LOOP
- ㉗ OPEN/CLOSE
- ㉘ DISC/USB
- ㉙ PROGRAM
- ㉚ ENTER
- ㉛ ▶ RIGHT
- ㉜ CLEAR/EQ
- ㉝ ZOOM
- ㉞ STOP
- ㉟ ▶▶ NEXT
- ㊱ ◀◀ PREVIOUS
- ㊲ VOLUME UP
- ㊳ DISPLAY
- ㊴ VOLUME DOWN
- ㊵ TIME
- ㊶ MPX
- ㊷ MIC ON (KARAOKE ON)
- ㊸ RESUME
- ㊹ # RAISE KEY (PITCH)

Connections

Before using the player, connect the player to a TV and/or amplifier.

Before making connections

- * Do not connect the AC power cord until all other connections have been made.
- * Connect VIDEO OUT of the player directly to the video input of your TV. Connecting VIDEO OUT of the player to a TV via a VCR may cause a monitor problem. You may also have a monitor problem when connecting the player to an integrated TV/Video system.

NOTE

- * In the following description, "TV" may be substituted with "monitor" or "projector".
- * Terminal names used for other components may be different from those used in the following description.

Connecting to a TV

The following sections (A) to (C) describe TV connections where only a TV is connected to the player so that you will hear sound also from the TV.

(A) Connecting to a conventional TV

Connect the Composite video output of the player to the video input of TV. Connect the 2 Channel Downmix Audio outputs to the audio inputs of TV.

(B) Connecting to a TV with an S-Video jack

If your TV has a S-VIDEO input, you can get better picture quality by connecting it with the S-VIDEO output of the player using an S-video cable instead of connecting the composite video input of the TV to the composite video output of the player.

NOTES

- * When using the S-VIDEO output jack, do not connect the COMPONENT VIDEO OUT jacks on the player.

(C) Connecting to a TV with component jacks

If your TV has COMPONENT video inputs, you can enjoy picture of high-fidelity color reproduction by connecting it with COMPONENT video outputs of the player.

NOTES

- * Connect "Y" to "Y", "PB" to "PB" (CB), "PR" to "PR" (CR) correctly.
- * When using the COMPONENT video output, do not connect the S-VIDEO output of the player.

Progressive scan video playback available

In the Progressive scanning mode, you can enjoy high quality picture with less flickers. The Progressive scanning mode works only when you connect the player and TV using COMPONENT video. See "Selecting preferences" at page 20 for more details.

NOTES

- * There are some progressive TV and High-Definition TV sets that are not fully compatible with the player, resulting in the unnatural picture when playing back a DVD VIDEO disc in the Progressive scanning mode. In such a case, use the Interlaced scanning mode.

Connecting to optional audio equipment

Connecting to a stereo audio amplifier / receiver

Connect the player's 2 Channel Downmix audio outputs (ML, MR) to any line-level inputs (such as AUX, DVD, CD, etc.) of an audio amplifier or receiver.

Connecting to Analog 5.1 Channel Dolby amplifier / receiver

Connect the player's Analog 5.1 Channel Dolby audio outputs (FL, FR, SUB, SL, SR, CEN) to an amplifier or receiver with 5.1 Channel Analog audio inputs.

Connecting to a digital audio device

You can enjoy sound of enhanced quality by connecting the player's DIGITAL (either OPTICAL or COAXIAL) audio outputs to a digital audio input of an amplifier or receiver, using an optical or coaxial digital cable. The digital audio signal including the Dolby Digital or DTS signal on a disc will be transferred directly from the player.

NOTE

- * Connect the player and the digital audio device by using either an optical digital cable or a coaxial digital cable.
- * It is not recommended to use the digital jacks for dubbing. When recording the sounds(DVD VIDEO, Video CD or Audio CD) played back on the player, record them through the analog (2 Channels or 5.1 Channels) outputs.
- * Depending on the disc, no signal may come out from the DIGITAL outputs. Make an analog connection in this case.
- * **Set SPDIF OUTPUT in the AUDIO SETUP correctly according to the connected digital audio equipment. If setting made for SPDIF OUTPUT is incorrect, loud noise may be generated causing damage to the speakers.**

Preparations

Connecting the power cord

When all the audio/video connections have been made, connect the AC power plug first to the player and then to the wall outlet. Make sure that the plugs are inserted firmly.

Warning

- * Disconnect the power cord:
 - if you are not going to use the player for a long time.
 - before cleaning the player.
 - before moving the player.
- * Do not:
 - connect or disconnect the power cord with wet hands.
 - pull the power cord when disconnecting it, as this may damage the cord and cause fire, electric shock, or other accidents.

Caution

- * Do not alter, twist or pull the power cord, or put anything heavy on it, which may cause fire, electric shock, or other accidents.
- * If the cord is damaged, consult a dealer and have the power cord replaced with a new one.

Remote sensor

Point the top of the remote control unit toward the remote sensor as directly as possible. If you operate it from a diagonal position, the operating range (approx. 5 m) may be shorter.

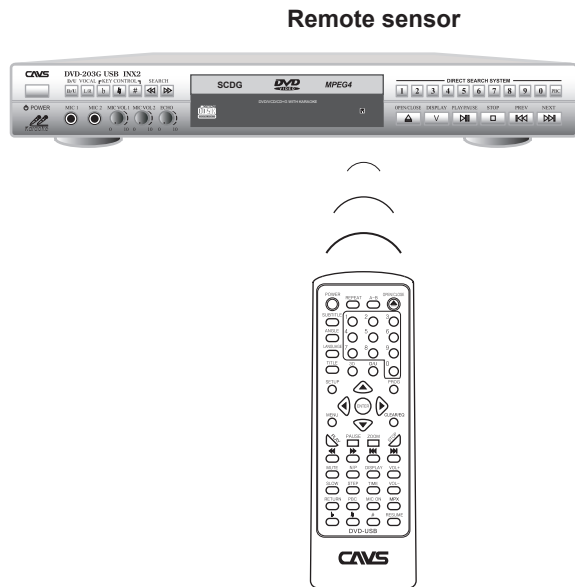

Using the remote control unit

To install batteries

Open the compartment cover, and place the two supplied R6(SUM-3)/AA(15F) batteries in the remote control unit according to the polarity marking ("+" and "-") inside the compartment. Then replace the cover.

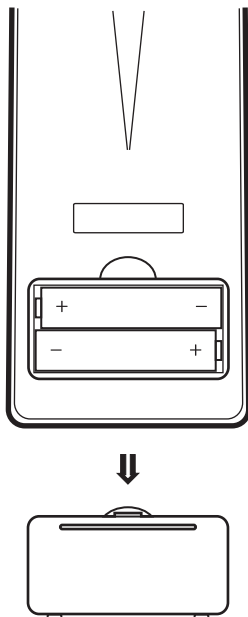

The batteries will last about six months with normal use. If the functions of the remote control unit become erratic, replace the batteries.

Precautions of the safe use of batteries

Observe the following precautions for the safe use of batteries. If they are used improperly their lives will be shortened, they may burst or their contents may leak.

- * Remove the batteries from the remote control unit if it is not going to be used for a long period of time.
- * Remove dead batteries and dispose of them properly.
- * Never leave dead batteries lying around, take them apart, mix them with other refuse, or throw them into an incinerator.
- * Never touch liquid that has leaked out of a battery.
- * Do not mix new and old batteries, or batteries of different types, when replacing them.

Basic operations

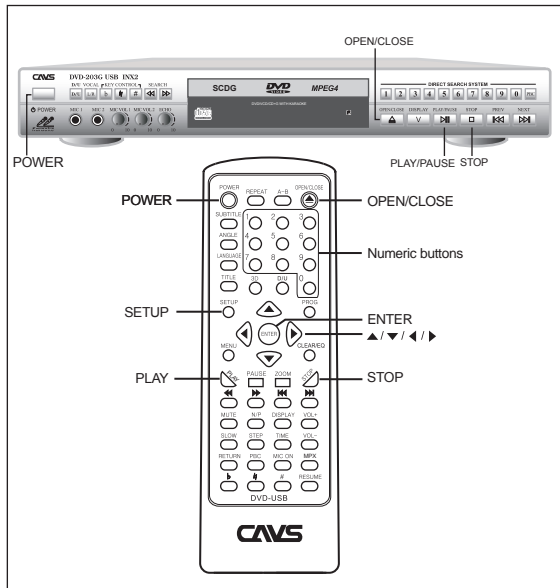

About invalid operation icon

When you press a button, and if the player does not accept its operation, appears on your TV screen. Operations are occasionally unacceptable even if is not displayed.

Note that some operations may not be accepted due to the media in play. For example, some discs may not allow rapid advance/reverse or slow-motion playback.

Turning on/off the player

Press POWER button on the front panel to turn on the player. The POWER button on the remote control works only when the POWER button on the front panel is pressed ON.

INITIALIZING message will first appear on the TV screen, followed by the opening display with CAVS logo. The duration of INITIALIZING will depend on the media inserted in the player.

NOTES

* Even if you turn off the player with the POWER button on the remote control, the player is not disconnected from the AC power source as long as the POWER button on the front panel is turned on. This state is called standby mode. In this state, the player consumes a very small amount of power.

Initial setup

When you turn on the player for the first time, you may want to change the settings in the player according your preferences. Use and ENTER buttons to navigate within SETUP menu.

1 Press SETUP.

The MAIN PAGE of SETUP MENU appears.

SET MENU --- MAIN PAGE

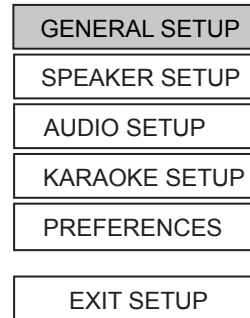

2 Select OSD language

The default OSD (on-screen display) language is English. To change, press ENTER to select GENERAL SETUP and go to OSD LANG. Move to a language of your choice and press ENTER.

-- GENERAL PAGE --

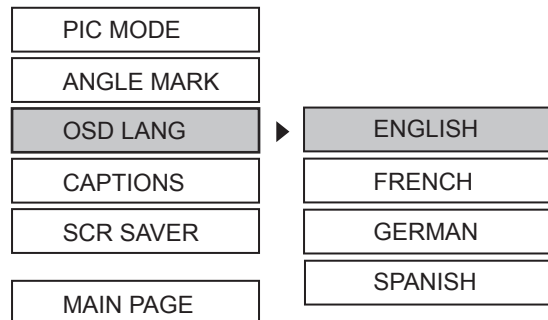

3 Select TV display.

Select PREFERENCES from the SETUP MENU. For a normal (conventional) TV, select NORMAL/PS or NORMAL/LB. For a wide-screen TV, select WIDE.

-- PREFERENCES PAGE --

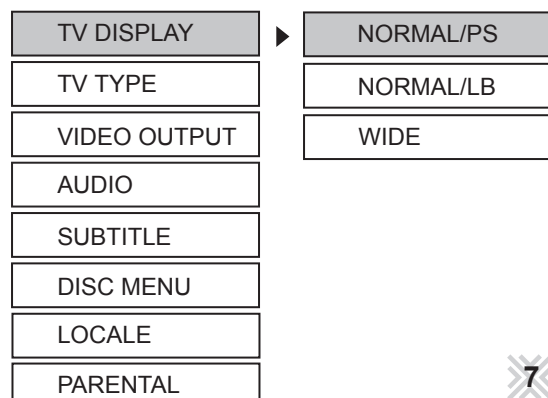

Basic operations

4 Select a desired Audio Output

Select an Audio Output according to your audio connection. Enter AUDIO SETUP from the SETUP MENU.

For COAXIAL or OPTICAL connection to digital amplifier or receiver, set the SPDIF OUTPUT to SPDIF/RAW or SPDIF/PCM. For Analog 5.1 Channel or Stereo (Karaoke) connection, set SPDIF OUTPUT to OFF.

-- AUDIO SETUP --

SPDIF OUTPUT	▶	OFF
OP MODE		SPDIF/RAW
DUAL MONO		SPDIF/PCM
COMPRESSION		
PRO LOGIC		
LPCM OUTPUT		
MAIN PAGE		

5 Select a desired Speaker Setup

Select according to your speaker connection.

For digital connection through COAXIAL or OPTICAL audio output, there is no need to adjust the SPEAKER SETUP in the SETUP menu. The adjustment needs to be made in the digital amplifier.

For Stereo (Karaoke) audio output, press MIC ON button on the remote control to set KARAOKE ON.

For Analog 5.1 Channel audio output, press MIC ON button on the remote control to set KARAOKE OFF. Each of the channel can further be adjusted in SPEAKER SETUP under SETUP menu. See "Selecting speaker setup" at page 22.

NOTE

- * Do not select a digital (SPDIF) output when the player is connected to TV or an audio system using Analog 5.1 Channel or Stereo (Karaoke) output of the player.
- * Microphone signal is only output through Stereo (Karaoke) audio output.

6 Press SETUP to return

The TV screen returns to the opening display.

Basic playback



1 Press OPEN/CLOSE to open the disc tray.

2 Place a disc in the disc tray.

3 Press OPEN/CLOSE to close the disc tray.

4 Press PLAY.

The player starts playback from the beginning.

If a menu is shown on the TV screen

When inserting a DVD VIDEO or Video CD disc, a menu may be shown on the TV screen. From the menu, you can select a desired item to be played back.

For DVD VIDEO

- 1 Press ▲/▼/◀/▶ to select a desired item.
- 2 Press ENTER.

The player starts playback of the selected item.

For Super CD+G

- 1 Input a song number or press ◀/▶ to select a desired song.
- 2 Wait for the display of title and press ENTER. The player starts playback of the selected song.

For INX, INX2

- 1 Input a song number or press ◀/▶ to select a desired song.
- 2 Wait for the display of title and press ENTER. The player starts playback of the selected song.

For Video CD

Press the numeric buttons to select a desired item. The player starts playback of the selected item.

NOTES

- * Do not insert an unplayable disc.
- * When inserting a disc on the disc tray, be sure to position the disc inside the recess. Otherwise, the disc may be damaged when the disc tray is closed, or you may not be able to remove the disc from the player.
- * If it takes time to read the loaded disc ("READING" appears on the display window), remove the disc by pressing OPEN/CLOSE on the remote control and check the disc.

Basic operations

To check the playback status

Press DISPLAY button on the remote control to see the current selection number (the title/chapter number for DVD VIDEO or track number for Video CD/Audio CD), time information (the time elapsed, or time remaining) on the TV screen.

To turn off the status bar

Press DISPLAY button repeatedly until the status bar goes off.

To stop playback temporarily

Press STOP button to stop playback.

To resume playback



Press PLAY or RESUME button to resume playback.

To stop playback completely

Press STOP button twice to stop playback completely. Next time the PLAY button is pressed, the playback will begin from the beginning of the disc

If you press OPEN/CLOSE button during playback, the player stops playback completely and opens the disc tray.

To pause playback

Press PAUSE button to pause playback. Press PLAY or PAUSE button again to resume playback.

Various speed playback

To advance or reverse playback rapidly while monitoring



During playback, press ►► or ◀◀ on the remote control unit.

You can select from 2 times, 4 times, 8 times, and 16 times normal speed. Pressing PLAY returns the player to normal playback.

NOTE

During rapid playback, the sound will be muted.

To advance a still picture frame by frame



While paused, press STEP button.

Each time you press STEP button, the still picture advances to the next frame. Pressing PLAY returns to normal playback.

To playback in slow motion



During playback, press SLOW button to play forward slow motion or reverse slow motion.

Press PLAY to return to normal playback.

NOTE

During slow motion playback, the sound will be muted. For Video CD, the reverse slow motion does not work.

Locating the beginning of a scene or song



During playback, you can skip a chapter or title, depending on the disc configuration.

To skip forward, press ►►.

To skip backward, press ◀◀ twice.

Using the numeric buttons

Press the numeric buttons to specify a chapter or title number.

The player starts playback from the beginning of the selection.

About screen saver function

A television monitor may have an image burned into it if a static image is displayed for a long time. To prevent this, the player automatically activates the screen saver function if a static picture, such as an on-screen display or menu, is displayed for over 5 minutes. When the screen saver function is activated, the TV screen gets darker. Pressing any buttons will release the screen saver function.

- * The screen saver function does not work when playing back the following sources:
 - AVI/JPEG (while in pause)
 - Audio CD

Advanced operations

▶▶▶ Playing from a specific position

To locate a desired scene from the DVD menu

DVD VIDEO

DVD VIDEO discs generally have their own menus which show the disc contents. These menus contain various items such as titles of movies, names of songs, or artist information, and display them on the TV screen. You can locate a desired scene using the DVD menu.

1 While a DVD VIDEO disc is inserted, press MENU.

The TV screen shows available items in the menu.

2 Press ▲ / ▼ / ◀ / ▶ to select a desired item, then press ENTER.

The player starts playback of the selected item.

Hint

* With some discs, you can select items by entering the corresponding number using the numeric buttons, which may cause the player to automatically start playback.

To locate a desired scene from the Video CD menu with PBC

Video CD

Some Video CD discs support the PBC function. PBC is an abbreviation of "Playback Control." Some Video CD discs recorded with PBC have their own menus, such as a list of the songs of the disc. You can locate a specific scene by using the PBC menu.

1 In stop mode, press PLAY.

A disc menu appears on the TV screen.

2 Press the numeric buttons to select the desired item.

The player starts playback of the selected item.
To return to the menu, press RETURN.

Hint

If something like "NEXT" or "PREVIOUS" appears on the TV screen, pressing ▶▶ advances to the next page, and pressing ◀◀ returns to the previous page.

To specify a desired title

DVD VIDEO

1 Press TITLE.

The TV screen shows available items in the menu.

2 Press ▲ / ▼ / ◀ / ▶ to select a desired item, then press ENTER.

The player starts playback of the selected item.

Hint

* With some discs, you can select items by entering the corresponding number using the numeric buttons, which may cause the player to automatically start playback.

To locate a desired position in the current title or track (Time search)

DVD VIDEO

Video CD

Audio CD

You can play a disc from the desired position by specifying the time from the beginning of the current title (for DVD VIDEO) or the disc (Video CD/Audio CD).

1 Press TIME twice.

The menu bar appears on the TV screen.

2 Press the numeric buttons (0 to 9) to enter the desired time.

Example (for DVD VIDEO)

To play back from 2(H):34(M):00(S)

Press 2, 3, then 4.

TIME 2:34:__

Example (for Video CD/Audio CD)

To play back from 23(M):40(S)

Press 2, 3, then 4.

TIME 23:4_

You do not have to press "0" to enter the trailing zeros (for the last two digits in the example above).

To correct a mistake

Press TIME repeatedly to reset and reenter a correct one.

3 Press ENTER.

The player starts playback from the specified time.

To dismiss the menu bar

Press TIME.

NOTES

* Some DVD VIDEO discs do not contain time information, and the time search function cannot be used.

* The time search function cannot be used during program playback.

Advanced operations

Changing the playback order

To playback in a specific order (Program play)

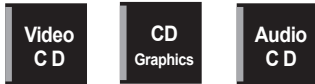

By programming tracks, you can play up to 99 tracks in any order. You may program the same track more than once.

- 1 In stop mode, press PROG.**
The menu bar appears on the TV screen.
- 2 Press the numeric buttons to specify track.**
- 3 Press ENTER.**
The specified track will be assigned a number of its order.
- 4 Press the number buttons to program the next track followed by ENTER. Continue to complete the programming.**
- 5 Press PLAY to start playback.**
- 6 To stop the program playback, press STOP.**
- 7 To clear the program, press STOP again.**

NOTES

- * When the disc tray is opened or the player is turned off, the program is cleared.
- * During Audio CD playback, you can select previous or next tracks by pressing **▶/◀**.
- * During VCD playback, you cannot search for the portion on the discs by pressing **▶/◀**.
- * During program playback, you can repeat playback.

Repeat playback

To repeat the current selection or all tracks



Press REPEAT.

If you press REPEAT in stop mode, press PLAY to start playback. Each time you press REPEAT, the repeat mode cycles among REP-ALL, REP-ONE and OFF. A window which indicates the current repeat mode will be displayed on the TV screen.

To stop repeat playback

Press STOP. The unit stops playback but does not quit the repeat mode.

To quit repeat playback

Press REPEAT until REPEAT OFF is displayed.

To repeat a desired part (A-B repeat playback)



- 1 Press A-B at the start of the part you want to repeat (point A).**

The A TO B SET A message appears.

- 2 Press A-B at the end of the part you want to repeat (point B).**

The A TO B SET B message appears and then changes to A TO B REPEAT ON. The player begins to repeat playback between "A" and "B".

To quit A-B repeat playback

Press A-B to turn off the A-B repeat mode. The A TO B CANCELLED message will appear and the normal playback continues.

NOTES

- * The A and B points must be set in the same title/chapter/track.
- * When you press STOP twice during DVD VIDEO playback, A-B repeat is canceled.

Changing the language, sound and scene angle

To select the subtitle language (SUBTITLE)



Some DVD VIDEO discs contain more than one subtitle language. You can choose a desired one from them.

Hint

At the beginning of the part where the subtitles are recorded,  appears on the TV screen.

- 1 During playback, press SUBTITLE.**
The subtitle selection window appears on the TV screen.
- 2 Press SUBTITLE repeatedly to make a selection.**
Each time you press SUBTITLE, the subtitle language changes.
- 3 Press SUBTITLE repeatedly to turn the subtitle off**
Press SUBTITLE until SUBTITLE OFF message appears.

NOTES

- * The subtitle selection window will automatically disappear if you do not change the subtitle for several seconds.

Advanced operations

To change the audio language or sound (LANGUAGE)



The audio selection setting allows you to change the audio language of a movie.

Hint

At the beginning of the part where the multiple audio tracks are recorded,  appears on the TV screen.

- 1 During playback, press LANGUAGE.**
The audio selection window appears on the TV screen.
- 2 Press LANGUAGE repeatedly to make a selection.**
Each time you press LANGUAGE, the audio changes.

NOTES

* The audio selection window will automatically disappear if you do not change the audio for several seconds.

To select a scene angle of DVD VIDEO (ANGLE)



You can enjoy a variety of scene angles if the DVD VIDEO disc contains "multi-angle" parts, where multiple cameras were used to shoot the same scene from different angles.

Hint

At the beginning of a "multi-angle" part,  appears on the TV screen.

- 1 During playback, press ANGLE.**
The angle selection window appears on the TV screen.
- 2 Press ANGLE repeatedly to make a selection.**
Each time you press ANGLE, the angle changes.





NOTE

The angle selection window will automatically disappear if you do not change the angle for several seconds.

Special picture/sound effect

To zoom in pictures



- 1 During playback or while paused, press ZOOM.**
Pressing ZOOM causes the player to zoom in on the image. Each time you press ZOOM, the magnification is changed (1.5, 2 and 3 times).
- 2 Press  /  /  /  to move the zoomed position.**
- 3 To return to normal play, press ZOOM repeatedly until ZOOM OFF message appears.**

NOTE

While zoomed, the picture may look coarse.

To change sound field (3D)



Using the Sound Effect (3D) function, you can change the sound field. This function is enabled only when Karaoke Setup is ON.

- 1 Press MIC ON to turn on the Karaoke Setup.**
The Karaoke indication appears on the TV screen.
- 2 During playback, press 3D.**
The Sound Effect (3D) indication appears on the TV screen.
- 3 Press 3D repeatedly to make a selection.**
Each time you press the button, the Sound Effect (3D) mode changes as follows:
- 4 Press 3D repeatedly to return to normal play.**

NOTE

The Sound Effect (3D) indication disappears if no operation is made for about few seconds.

Karaoke operations

» Karaoke Operations



- 1 Press MIC ON to set KARAOKE MODE ON.**

This enables the key control and voice cancel (MPX) features in the player. The SPEAKER SETUP is also automatically changed to DOWNMIX: STEREO.

 - * Be sure to set SPDIF OUTPUT as OFF in AUDIO SETUP.
 - * Microphone signal is only output through 2 Channel Downmix (ML/MR) audio output terminals.
- 2 Insert a karaoke disc and select a song for playback.**

Each disc may require different steps to search through menus and playback a song.
- 3 Adjust the volume and echo level of the microphones using VOL1, VOL2, and ECHO control knobs.**

Be sure to turn on the microphones.
- 4 Press VOL + and VOL - buttons on the remote control to adjust the volume level of playback music in relation to the microphones.**
- 5 Adjust the key (pitch) of the song by pressing \flat and \sharp buttons according to your preference.**
- 6 Press MPX button to set OFF / ON the lead vocal in the song, to practice along or to sing in solo.**
 - * In most DVD Karaoke discs, the voice cancel feature is controlled by LANGUAGE button.
 - * Only certain karaoke discs (multiplex format) have embedded lead vocals that can be set ON or OFF.

Super CD+G (SCDG) Operations



- 1 Insert the SCDG disc into the player.**

After reading the disc, the initial SCDG screen will appear on the TV screen..
- 2 Using numeric buttons, input a song number or using \blacktriangleleft / \blacktriangleright buttons, search for a song.**

Wait for the title of the song to appear on the screen. Press ENTER or PLAY to begin playback
When selecting a song after a rest or other operations such as changing SETUP menu, it may take longer for the song title to appear. Be sure to wait for the title before pressing ENTER or PLAY to begin playback.
- 3 To program next songs, enter the song numbers followed by pressing of PROG after each entry.**

The programmed song will appear on the lower left corner of the screen. You can program up to 10 songs.

The programmed songs will play one song at a time, waiting for a press of PLAY button at the end of each song.

To see the list of programmed songs, press PROG. The list will be displayed at the bottom of the TV screen.

NOTE

The programming is possible only when the player is currently playing a song.

- 4 To cancel a programmed song, press STOP.**

If stopped during playback, the song in play will be canceled. If stopped while waiting for the next programmed song, the song in waiting will be canceled.
- 5 To see playback status, press DISPLAY.**

Elapsed time and remaining time of the song will appear sequentially. Press DISPLAY again to dismiss the playback status.
- 6 Press PAUSE to pause the playback. Press PLAY to resume playback.**

Karaoke operations

INX, INX2 Operations

INX
INX2

1 Insert the INX or INX2 disc into the player.

After reading the disc, the initial CAVS INX screen will appear on the TV screen..

2 Using numeric buttons, input a song number or using ◀/▶ buttons, search for a song.

Wait for the title of the song to appear on the screen. Press ENTER or PLAY to begin playback. When selecting a song after a rest or other operations such as changing SETUP menu, it may take longer for the song title to appear. Be sure to wait for the title before pressing ENTER or PLAY to begin playback.

3 Search a song by title or singer name.

Press MENU to select Help, Search by Title, or Search by Singer display.

See the Help display for instruction on how to search a song by title or singer.

To search by title, use the 4-way direction buttons to spell the title at the Search by Title display. When a list of songs is shown on the display, you can continue spelling the title or use the FF, FR, NEXT, PREV buttons to move the cursor by line or page to select a song.

Press ENTER or PLAY to start the song. Press STOP or CLEAR to return to the initial CAVS INX (or SDK) display.

To search by singer, use the 4-way direction buttons to spell the singer's name at the Search by Singer display. When a list of songs is shown on the display, you can continue spelling the singer's name or use the FF, FR, NEXT, PREV buttons to move the cursor by line or page to select a song.

Press ENTER or PLAY to start the song. Press STOP or CLEAR to return to the initial CAVS INX (or SDK) display.

4 (For INX2 only) To turn on or off the background video.

Press STOP or CLEAR for the initial CAVS INX (or SDK) screen.

Press DISPLAY to turn on or off the background video.

5 To program next songs, enter the song numbers followed by pressing of PROG after each entry.

The programmed song will appear on the lower left corner of the screen. You can program up to 10 songs.

The programmed songs will play one song at a time, waiting for a press of PLAY button at the end of each song.

To see the list of programmed songs, press PROG. The list will be displayed at the bottom of the TV screen.

NOTE

The programming is possible only when the player is currently playing a song.

6 To cancel a programmed song, press STOP.

If stopped during playback, the song in play will be canceled. If stopped while waiting for the next programmed song, the song in waiting will be canceled.

7 To see playback status, press DISPLAY.

Elapsed time and remaining time of the song will appear sequentially. Press DISPLAY again to dismiss the playback status.

8 Press PAUSE to pause the playback. Press PLAY to resume playback.

Audio/Video files playback

Outline

The player can play AVI / MP3 / JPEG files on a personally recorded media as follows:

CD-R/RW, DVD±R, DVD±R DL, DVD-RW

Some discs mastered as multi border (multi-session) may not be compatible with the player.

You can select and play back files using the SMART NAVI display on the TV screen.

* The player may be unable to play back the media due to the characteristics or recording conditions.

Precautions

About files and folders on the disc

- * Files may be grouped into folders, and the folders organized under "Root" folder, which represent the inserted disc.
- * The player can detect and play back the folders which are located up to the fifth layer.
- * The files in the SMART NAVI display are arranged by the alphabetical order of extensions as follows: ".avi", ".jpeg", and ".mp3".
- * Time required for reading the media contents may vary for different media, depending on the numbers of folders (groups) and files recorded, etc.
- * The player recognizes up to 1,000 files per folder, and up to 250 folders per disc.

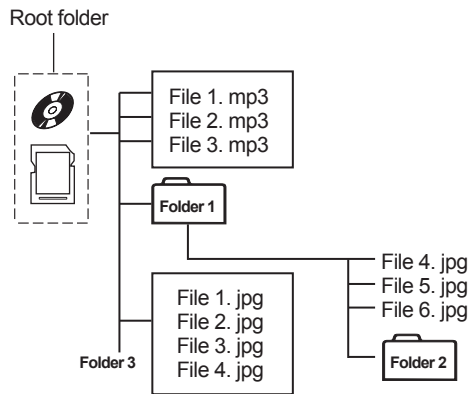

Notes for making your own disc

- * Use "UDF format" as the disc format for DVD±R / DVD±R DL / DVD-RW.
- * Use "ISO 9660" as the disc format for CD-R / CD-RW.
- * The player does not support "packet writing" for CD-R /RW.
- * The player supports discs recorded with up to five multiple sessions.
- * The player may not recognize the full 1,000 files and 250 folders due to the disc or file characteristics.
- * Some disc may not play due to media characteristics or recording conditions.

Notes for making files/folders

- * If a file name includes even one 2-byte character, the player may not show the file name correctly.
- * The player supports up to 9 characters as the file / folder names.
- * The player can only recognize files with one of the following extensions, which can be in any combination of upper and lower case.
 - For MP3 files, ".MP3", ".mp3".
 - For JPEG files, ".JPG", ".JPEG", ".jpg", ".jpeg".
 - For MPEG-4 files, ".AVI", ".avi".
- * **For MP3 files:**
 - It is recommended that you record your material at 44.1 KHz sampling rate, using the 128 kbps data transfer rate.
 - ID3 Tag is not available.
 - MP3i and MP3 Pro are not available.
- * **For JPEG files:**
 - We recommend you to record your material at a 640*480 pixel resolution.
 - This player supports the baseline JPEG format.
 - The player does not support a baseline-formatted picture of more than 5120*3413 pixels. Make sure that the pictures pixel size is 5120*3413 pixels or less.
 - This player cannot play back a progressive JPEG file of more than 2048*1536 pixels.
- * **For MPEG-4 files:**
 - The player supports the AVI files whose resolution is 640*480 pixels or less, and created using 4 Mbps ASP codec.
 - The size of the playback screen will be the same size as it is recorded.
 - Some recorded files may not be able to be played back depending on file characteristics, kind of digital still/video cameras, or recording conditions.
 - The player can playback the following MPEG-4 files:
 - MPEG-4 V2: Simple(single) stream
 - MPEG-4 V3: Fully supported
 - (MPEG-4 V1 file is not compatible.)

Audio/Video files playback

Basic operations

When you insert a disc with folders and files, the player will automatically begin playback of the AVI, MP3, JPEG contents. Press STOP and the SMART NAVI display that shows the folders and files will appear on the TV screen. You can specify and play back the desired folder/file from the SMART NAVI display using the following procedure.

1 Press STOP to stop the playback.

The SMART NAVI display will show the contents of the disc on the TV screen.

-- SMART NAVI --

ROOT	...	0
CD01	MP3 001	1
	MP3 002	2
	MP3 003	3
	MP3 004	4
	MP3 005	5

2 Press ▲/▼/◀/▶ to move the bar to a desired folder position and press ENTER.

In the right column, files in the selected folder are shown.

3 Press ▲/▼/◀/▶ to select the desired file, then press ENTER.

The selected file will begin to playback.

- * When you press ENTER, the continuous playback starts from the selected file. The playback stops after playing back of all files in the same FOLDER.
- * You can also change the files on the list by pressing ◀/▶ or the numeric buttons.

To pause playback

Press II.

Pressing PLAY resumes normal playback.

To reverse or advance playback rapidly

Press ◀/▶ during playback of AVI / MP3.

- * Each time you press ◀ (or ▶), the player reverses (or advances) playback, rapidly changing the playback speed.

To zoom in a picture

Press ZOOM.

- * Each time you press ZOOM, the magnification is changed.
- * The 3 time magnification may not work for some AVI / JPEG files according to their resolutions.
- * Pressing ▲/▼/◀/▶ moves the zoomed position during playback of JPEG file.

To cancel the zoom function, select the normal size by pressing ZOOM repeatedly.

To rotate/reflect a still picture

While the still picture is played back:

- * Pressing ► rotates the picture by 90° clockwise.
- * Pressing ◀ rotates the picture by 90° counterclockwise.
- * Pressing ▼ rotates the picture vertically.
- * Pressing ▲ rotates the picture horizontally.

To stop playback

Press STOP.

The SMART NAVI display appears on the TV.

NOTES

- * Opening the disc tray stops playback.
- * It may take time to show the SMART NAVI display due to the layer configuration of the files and folders.
- * The elapsed time may be incorrectly indicated on the display window due to the recording condition of the file.
- * The display window cannot show the file number more than 100. When the files numbered over 100th are played back, the player re-counts file number again from 0.
- * When the screen saver starts, the SMART NAVI display disappears.

To change PLAY MODE.

Press REPEAT to change the PLAY MODE.

PLAY MODE	FUNCTION
SINGLE	SELECTED FILE ONLY
REP - ONE	REPEAT SELECTED FILE
FOLDER	ALL FILES IN FOLDER
FOLDER REPEAT	REPEAT ALL FILES IN FOLDER
DISC SCAN	SCAN ALL FILES IN DISC
DISC	ALL FILES IN DISC
DISC REPEAT	REPEAT ALL FILES IN DISC

During playback, you can also press REPEAT to change the PLAY MODE.

To program files

Press PROG to change the PLAY MODE to PROGRAM. Select a file and press ENTER to program. Repeat the process of selecting a file and pressing ENTER to program. Press STOP to finish the programming. Press PLAY to start playback.

USB memory device operations

Outline

The player can play AVI / CD+G (MP3+MCG) / CD+G (MP3G) / MP3 / JPEG files on USB memory devices as follows:

External hard drive (FAT32), Memory stick (FAT32).

The memory devices can be of any size and capacity. They must be configured in FAT32 format, and some may require self power supply in order to operate. You can select and play back files using the SMART NAVI or INX menu display on the TV screen.

* The player may be unable to play back the media due to incorrect format or file specification.

Precautions

About files and folders on the device

- * Files may be grouped into folders, and the folders organized under "Root" folder, which represents the connected media.
- * The player can detect and play back the folders which are located up to the fifth layer.
- * The files in the SMART NAVI display are arranged by the alphabetical order of extensions as follows: ".avi", ".jpeg", and ".mp3".
- * Time required for reading the media contents may vary for different media, depending on the numbers of folders and files recorded, etc.
- * The player recognizes up to 500 files per folder, and up to 250 folders per media.

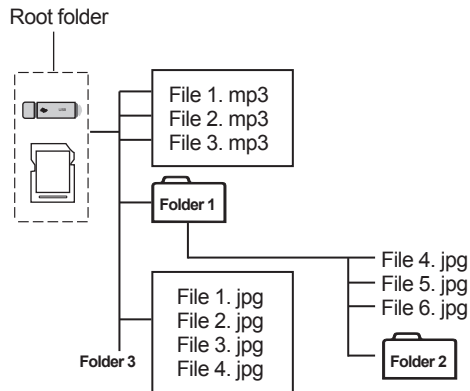

Notes for making your own device

- * Use FAT32 format for USB memory devices.
- * Use "ISO 9660" file naming format.
- * The player may not recognize the full 500 files and 250 folders due to the media or file characteristics.
- * Some devices may not play due to its media format or file specifications.

Notes for making files/folders

- * If a file name includes even one 2-byte character, the player may not show the file name correctly.
- * The player supports up to 9 characters as the folder / file names.
- * The player can only recognize files with one of the following extensions, which can be in any combination of upper and lower case.
 - For MP3 files, ".MP3", ".mp3".
 - For JPEG files, ".JPG", ".JPEG", ".jpg", ".jpeg".
 - For MPEG-4 files, ".AVI", ".avi".
 - For CD+G (MP3+MCG) files, "MP3", "mp3", "MCG", "mcg".
 - For CD+G (MP3G) files, "MP3", "mp3".

* For MP3 files:

- It is recommended that you record your material at 44.1 KHz sampling rate, using the 128 kbps data transfer rate.
- ID3 Tag is not available.
- MP3i and MP3 Pro are not available.

* For JPEG files:

- We recommend you to record your material at a 640*480 pixel resolution.
- This player supports the baseline JPEG format.
- The player does not support a baseline-formatted picture of more than 5120*3413 pixels. Make sure that the pictures pixel size is 5120*3413 pixels or less.
- This player cannot play back a progressive JPEG file of more than 2048*1536 pixels.

* For MPEG-4 files:

- The player supports the AVI files whose resolution is 640*480 pixels or less, and created using 4 Mbps ASP codec.
- The size of the playback screen will be the same size as it is recorded.
- Some recorded files may not be able to be played back depending on file characteristics, kind of digital still/video cameras, or recording conditions.
- The player can playback the following MPEG-4 files:
 - MPEG-4 V2: Simple(single) stream
 - MPEG-4 V3: Fully supported
 - (MPEG-4 V1 file is not compatible.)

* For Karaoke Song files:

There are two type of CD+G karaoke files that can be played from a USB memory device in the player:

- CD+G (MP3+MCG)
- CD+G (MP3G).

Both types of files can be downloaded from www.cavsusa.com/cinet_home. The CD+G (MP3+CDG) karaoke song files, also compatible to many of CAVS professional models, consist of MP3 and MCG components. The CD+G(MP3G) files, newly introduced, combines the two components to a single composite MP3 file.

USB memory device operations

CD+G (MP3+MCG)

- All CAVS CD+G (MP3+MCG) karaoke song files are compatible to the player.
- Go to www.cavsusa.com/cinet_home to download the karaoke song files. Save the downloaded song files into your PC, and double click on the saved files to unzip into MP3 and MCG components for each song. In you are not using Win XP in your PC, use Tugzip or Winzip programs available in the Internet to unzip the downloaded files.
- You can also make your own MP3+MCG karaoke song files from any standard CD+G discs using Encoder MCG program available at www.cavsusa.com/playcdg_home. Download the program and follow the instruction within.
- For each song, the MP3 and MCG components should always be named in the same way, followed by .mp3 and .mcp extensions respectively. For example, 21000032.mp3 and 21000032.mcp would be the MP3 and MCG components of a song.
- SMART NAVI menu can display up to 500 karaoke songs per folder. This restriction comes from the player's capacity to store file names.
- To display and manage up to 49,999 song files per folder, you can use the INX menu, which will appear when an INX menu file is included in the folder. To create the INX menu file, go to www.cavsusa.com/cinet_home and download the INXMENU program. Follow the instruction within to create the INX menu file (English.inx) and insert it into the folder.

CD+G (MP3G)

- CAVS CD+G (MP3G) karaoke song files can also be played from a USB memory device in the player. This new karaoke file format combines the audio and graphic components of a song into a single composite MP3 file. The file is named, for example, 21000032-mcp.mp3.
- Go to www.cavsusa.com/cinet_home to download the karaoke song files. Save the downloaded song files into your PC, and double click on the saved files to unzip into MP3 files. In you are not using Win XP in your PC, use Tugzip or Winzip programs available in the Internet to unzip the downloaded files.
- SMART NAVI menu can display up to 500 karaoke songs per folder. This restriction comes from the player's capacity to store file names.
- To display and manage up to 49,999 song files per folder, you can use the INX menu, which will appear when an INX menu file is included in the folder. To create the INX menu file, go to www.cavsusa.com/cinet_home and download the INXMENU program. Follow the instruction within to create the INX menu file (English.inx) and insert it into the folder.

Basic operations

Connect the USB memory device to USB IN terminal located on the back panel of the player. You may use the USB cable, included as accessory, for an extended reach.

Warning







Disconnect the USB memory device from the player only when the player is:

- powered off.
- playing from an optical disc.
- assigned to the disc play mode.

1 Press D/U to display DISC DRIVE / USB DEV selection menu.

The D/U button will only work when the player is in Stop mode. Select USB DEV by pressing ◀ / ▶ followed by PLAY or ENTER. The SMART NAVI display will show the contents of the USB device on the TV screen.

-- SMART NAVI --

 ROOT	 ... 0
	 CAVS INX1
	 CAVS INX2
	 CAVS MCG1
	 CAVS MCG2

2 Press ▲ / ▼ or ◀ / ▶ to move the bar to a desired folder position and press ENTER.





- * When the folder contains INX menu file, the CAVS INX screen will appear. Follow the instruction to select and play a song. See INX, INX2 operation in Chapter: Karaoke Operations.

To exit the CAVS INX menu and go to another folder, press D/U, and press ENTER.

- * When the folder contains CD+G (MP3+MCG) or CD+G (MP3G) karaoke song files without the INX menu file, the SMART NAVI menu will show the MP3 files on the right column. MCG files will not appear on the screen.

- * For all other folders, the files contained within will appear on the right column. Files of format or specification that are not recognized by the player, may appear with "?" mark or not appear at all on the screen.

-- SMART NAVI --

 ROOT	 ... 0
 CAVS INX1	MP3 001 1
 CAVS INX2	MP3 002 2
 CAVS MCG1	MP3 003 3
	MP3 004 4

USB memory device operations

3 Press ▲/▼ or ◀/▶ to select the desired file, then press ENTER.

- * You can also press ◀/▶ to move by page-up or page-down in the list.
- * When you press ENTER, the selected file will begin playing. During play, press ◀/▶ to change to the next or previous file.
- * You can also select a file by entering its file number shown on the right side of the file name. Input the number and press ENTER to play.

To pause playback

Press II.
Pressing PLAY resumes normal playback.

To reverse or advance playback rapidly

Press ◀/▶ during playback of AVI / MP3.
* Each time you press ◀ (or ▶), the player reverses (or advances) playback, rapidly changing the playback speed.

To zoom in a picture

Press ZOOM.
* Each time you press ZOOM, the magnification is changed.
* The 3 time magnification may not work for some AVI / JPEG files according to their resolutions.
* Pressing ▲/▼/◀/▶ moves the zoomed position during playback of JPEG file.
To cancel the zoom function, select the normal size by pressing ZOOM repeatedly.

To rotate/reflect a still picture

While the still picture is played back:
* Pressing ▶ rotates the picture by 90 clockwise.
* Pressing ◀ rotates the picture by 90 counterclockwise.
* Pressing ▼ rotates the picture vertically.
* Pressing ▲ rotates the picture horizontally.

To stop playback

Press STOP.
The SMART NAVI display appears on the TV.

NOTES

- * Opening the disc tray stops playback.
- * It may take time to show the SMART NAVI display due to the layer configuration of the files and folders.
- * The SMART NAVI menu cannot show the file number more than 500. When the files numbered over 500th are played back, the player re-counts file number again from 0.
- * When the screen saver starts, the SMART NAVI display disappears.

To change PLAY MODE.

Press REPEAT to change the PLAY MODE.

PLAY MODE	FUNCTION
SINGLE	SELECTED FILE ONLY
REP - ONE	REPEAT SELECTED FILE
FOLDER	ALL FILES IN FOLDER
FOLDER REPEAT	REPEAT ALL FILES IN FOLDER
DISC SCAN	SCAN ALL FILES IN DISC
DISC	ALL FILES IN DISC
DISC REPEAT	REPEAT ALL FILES IN DISC

* During playback, you can also press REPEAT to change the PLAY MODE.

* The term "DISC" refers to the USB memory device connected to the player.

* The PLAY MODE feature does not apply to the INX, CD+G (MP3+MCG), or CD+G (MP3G) karaoke file folders.

To program files

Press PROG to change the PLAY MODE to PROGRAM.
Select a file and press ENTER to program. Repeat the process of selecting a file and pressing ENTER to program.
Press STOP to finish the programming. Press PLAY to start playback.

To return to Disc play

Be sure the player is in Stop mode. Press D/U to display the DISC DRIVE / USB DEV selection menu. Select DISC DRIVE by pressing ◀/▶ followed by PLAY or ENTER.
The player will become standby for a disc play.

Changing the initial settings

Selecting PREFERENCES

This section refers to the settings which are already made when you purchase the player. Read this section when you want to change settings according to your preferences and viewing environment.

1 Press SETUP.

2 Press ▲/▼ to select PREFERENCES.

The color of the selected item changes.

3 Press ENTER.

The PREFERENCES menu appears on the TV screen.

-- PREFERENCES PAGE --

TV DISPLAY	▶	NORMAL/PS
TV TYPE		NORMAL/LB
VIDEO OUTPUT		WIDE
AUDIO		
SUBTITLE		
DISC MENU		
LOCALE		
PARENTAL		
PASSWORD		
DEFAULTS		
SMARTNAVI		



To dismiss PREFERENCES PAGE display

Press SETUP.

NOTES

* PREFERENCES cannot be changed during disc playback.

TV DISPLAY

Select the TV DISPLAY for your viewing preference.

Setting options

NORMAL/PS - 4 x 3 Full TV screen
NORMAL/LB - 4 x 3 Movie screen
WIDE - 16 v 9 Wide screen TV

TV TYPE

Select the TV TYPE to match your TV.

Setting options

MULTI, NTSC, PAL

* You can also select the TV TYPE by pressing N/P button on the remote control.

VIDEO OUTPUT

You can select the video output to best match your TV for higher video quality.

Setting options

SVIDEO - For Composite or S-Video connections
YCBCR - For Component connection
SCART - For European connection
YPBPR - For Progressive Scan connection
VGA - For VGA PC Monitor connection

* Your TV may have more than one connection. If available, use Component output for higher quality video.

* You cannot change the setting during playback.

AUDIO

You can select the default audio language to be displayed if it is contained on a DVD VIDEO disc.

Setting options

ENGLISH, SPANISH, FRENCH, CHINESE, GERMAN, ITALIAN, JAPANESE, language code from AA TO ZU

* If the disc does not have the selected language, the disc's default language will be used.

* You cannot change the setting during playback.

SUBTITLE

You can select the default subtitle language to be displayed if it is contained on a DVD VIDEO disc.

Setting options

OFF, ENGLISH, SPANISH, FRENCH, CHINESE, GERMAN, ITALIAN, JAPANESE, language code from AA TO ZU

* If the disc does not have a subtitle in the language, the disc's default language will be used.

* You cannot change the setting during playback.

DISC MENU

You can select the default disc menu language to be displayed if it is contained on a DVD VIDEO disc.

Setting options

ENGLISH, SPANISH, FRENCH, CHINESE, GERMAN, ITALIAN, JAPANESE, language code from AA TO ZU

* If the disc does not have a subtitle in the language, the disc's default language will be used.

* You cannot change the setting during playback.

LOCALE

You can select the default locality code to be displayed if it is contained on a DVD VIDEO disc.

Setting options

CHINA, FRANCE, HONG KONG, JAPAN, TAIWAN, GBR, USA

* If the disc does not have a locality code, the disc's default locality code will be used.

* You cannot change the setting during playback.

Changing the initial settings

PARENTAL

You can select the level of restriction on DVD VIDEO playback that contains violent (and other) scenes. For example, if movie which includes violent scenes supports the parental rating, such scenes will be cut or replaced with other scenes.

Setting options

G, PG, PG-13, PG-R, NC-17, ADULT, NO PARENTAL

- * Some of the options are blank in expectation of new ratings to come in the future.
- * You cannot change the setting during playback.

PASSWORD

You can change the password to PREFERENCES SETUP so that settings within, such as PARENTAL, can only be changed by you. The factory default password is "3308". Enter the current password and new password (twice) to change.

- * Password must consists of 4 digits.
- * You cannot change the setting during playback.

DEFAULTS

You can re-set the SETUP menu with factory default values. It will re-set all existing options.

- * You cannot change the setting during playback.

SMARTNAVI

You can select to turn on or off the SMART NAVI menu on screen.

Setting options

NO MENU, WITH MENU

- * You cannot change the setting during playback.

PIC MODE

You can select whether the content on the disc is processed by field (video source) or by frame (film source).

Setting options

AUTO - Video & film contents
FILM - Film contents
VIDEO - Video contents
SMART - Video & film, normal & active
SUPER SMART - Video & film, normal & active

- * Normally, SUPER SMART is selected.

ANGLE MARK

You can select to display multi-angle mark when contents on a disc contains multi-angle video shots.

Setting options

ON, OFF

OSD LANG

You can select the on-screen display language of the player.

Setting options

ENGLISH, SPANISH, FRENCH, GERMAN

- * Some screen messages are shown in English regardless of the setting.
- * You cannot change the language shown in SMART NAVI.

CAPTIONS

You can select ON to see the captions in the contents of the disc.

Setting options

ON, OFF

SCREEN SAVER

You can set the screen saver function to ON or OFF.

Setting options

ON, OFF

Selecting GENERAL SETUP

This section refers to the settings which are already made when you purchase the player. Read this section when you want to change settings according to your preferences and viewing environment.

1 Press SETUP.

2 Press ▲/▼ to select GENERAL SETUP.

The color of the selected item changes.

3 Press ENTER.

The GENERAL SETUP menu appears on the TV screen.

-- GENERAL PAGE --

PIC MODE	▶	AUTO
ANGLE MARK		FILM
OSD LANG		VIDEO
CAPTIONS		SMART
SCREEN SAVER		SUPER SMART
MAIN PAGE		

To dismiss GENERAL SETUP display

Press SETUP or move the bar to MAIN PAGE and press ENTER.

Changing the initial settings

Selecting SPEAKER SETUP

This section refers to the settings which are already made when you purchase the player. Read this section when you want to change settings according to your preferences and viewing environment.

1 Press SETUP.

2 Press ▲/▼ to select SPEAKER SETUP.

The color of the selected item changes.

3 Press ENTER.

The SPEAKER SETUP menu appears on the TV screen.

-- SPEAKER SETUP PAGE --

DOWNMIX	▶	LT/RT
CENTER		STEREO
REAR		VSS
SUBWOOFER		5.1 CHANNEL
CENTER DELAY		
REAR DELAY		
TEST TONE		
MAIN PAGE		

To dismiss SPEAKER SETUP display

Press SETUP or move the bar to MAIN PAGE and press ENTER.

DOWNMIX

You can select a downmix option when the player is connected to an amplifier (sound system) using analog audio outputs.

Setting options

- LT/RT** - Analog amplifier with Dolby Prologic decoder connected to the 2 channel downmix outputs.
- STEREO** - Analog stereo amplifier connected to the 2 channel downmix outputs.
- VSS** - Analog amplifier with virtual surround sound connected to the 2 channel downmix outputs.
- 5.1 Ch** - 5.1 channel analog amplifier connected to analog 5.1 channel outputs.

SPEAKER SETUP

The following speaker setup can only be selected when KARAOKE SETUP is turned off.

- CENTER** - Select ON if you are using the center speaker.
- REAR** - Select ON if you are using the rear L/R speakers.
- SUBWOOFER** - Select ON if you are using the subwoofer speaker.
- CENTER DELAY** - Select delay time of the center speaker.
- REAR DELAY** - Select delay time of the rear L/R speakers.

* For 5.1 Channel Surround Sound, the best sound effect can be achieved when the distance between the audience and each speaker is the same. Set the CENTER DELAY and REAR DELAY to achieve this equal distance.

TEST TONE

You can select ON to perform a speaker output test. The test will be performed in the order of Front Left, Center, Front Right, Rear Left, Rear Right, and Subwoofer.

Selecting AUDIO SETUP

This section refers to the settings which are already made when you purchase the player. Read this section when you want to change settings according to your preferences and viewing environment.

1 Press SETUP.

2 Press ▲/▼ to select AUDIO SETUP.

The color of the selected item changes.

3 Press ENTER.

The AUDIO SETUP menu appears on the TV screen.

-- AUDIO SETUP --

SPDIF OUTPUT	▶	OFF
OP MODE		SPDIF/RAW
DUAL MONO		SPDIF/PCM
COMPRESSION		
PRO LOGIC		
LPCM OUTPUT		
MAIN PAGE		

To dismiss AUDIO SETUP display

Press SETUP or move the bar to MAIN PAGE and press ENTER.

SPDIF OUTPUT

You can select between digital outputs (COAXIAL and OPTICAL) and analog outputs (DOWNMIX).

Setting options

- OFF** - Analog audio output for downmix connections.
- SPDIF/RAW** - Digital audio output with Digital Dolby, DTS, etc.
- SPDIF/PCM** - Digital audio output with 2 channel stereo.

Changing the initial settings

OP MODE

You can select between a direct connection or a connection through RF Remodulator (or VCR player) to TV.

Setting options

- LINE OUT** - Direct connection to TV.
RF REMOD - Connection through RF Remodulator to TV.

DUAL MONO

You can select the mode of analog outputs (DOWNMIX).

Setting options

- STEREO** - Stereo output.
L-MONO - Left mono output.
R-MONO - Right mono output.
MIX-MONO - Left and right mono output.

COMPRESSION

You can select the level of dynamic range compression in the audio output. Normally, it should be set at FULL.

Setting options

FULL, 7/8, 6/8, 5/8, 4/8, 3/8, 2/8, 1/8, OFF

PRO LOGIC

You can select ON when listening to surround multi-channel sound with the player's analog audio output connected to a surround decoder.

Setting options

OFF, ON, AUTO

LPCM OUTPUT

You can select the quality of the linear PCM digital sound of the player. Normally, it should be set at 96KHz.

Setting options

LPCM 48K, LPCM 96K

KARAOKE MODE

You can select ON for karaoke playback that would enable key control and voice cancel features.

Setting options

OFF, ON

- * Selecting KARAOKE MODE ON automatically changes the speaker output to DOWNMIX STEREO.
- * SPDIF OUTPUT should be OFF in AUDIO SETUP.
- * Pressing MIC ON on the remote control also changes KARAOKE MODE.

Selecting EQUALIZER

This section refers to the settings in EQUALIZER which are already made when you purchase the player. Read this section when you want to change settings according to your preferences and viewing environment.

1 Press CLEAR/EQ.

The EQUALIZER menu appears with TYPE: STANDARD, which you can change by pressing ENTER. The selection will rotate among STANDARD, CLASSIC, JAZZ, ROCK, POPS, BALLAD, DANCE, and PERSONAL.

2 Press ENTER repeatedly to select PERSONAL.

3 Press ◀ / ▶ to select a frequency block.

The color of the selected block will turn to yellow.

4 Press ▲ / ▼ to select a volume level for the frequency block.

The volume level will go up or down accordingly.

5 Press CLEAR/EQ to change to SPECTRUM display.

The SPECTRUM will display the volume levels of each frequency block during playback.

6 Press CLEAR/EQ to turn off SPECTRUM display.

The SPECTRUM display will disappear but the EQUALIZER is still in effect.

7 Press CLEAR/EQ to turn off EQUALIZER.

The EQUALIZER OFF message will appear. The message will also clear in 2 seconds.

Selecting KARAOKE SETUP

This section refers to the settings which are already made when you purchase the player. Read this section when you want to change settings according to your preferences and viewing environment.

1 Press SETUP.

2 Press ▲ / ▼ to select KARAOKE SETUP.

The color of the selected item changes.

3 Press ENTER.

The KARAOKE SETUP menu appears on the TV screen.

-- KARAOKE PAGE --

KARAOKE MODE	▶	OFF
		ON
MAIN PAGE		

To dismiss KARAOKE SETUP display

Press SETUP or move the bar to MAIN PAGE and press ENTER.

Additional information

Troubleshooting

Power

Power does not come on.

- ⇒ Power plug is not inserted securely. Plug in securely.

Operation

"REGION CODE ERROR!" is shown on the TV screen.

- ⇒ Region code of the inserted disc does not match the player. Check the region code of the disc printed on the disc jacket. To change the region code of the player, please visit www.cavsusa.com.

Operation is not possible.

- ⇒ Microcomputer malfunction due to lightning or static electricity. Turn off the power and unplug the power cord, then connect the power cord again.
- ⇒ Moisture condensation caused by a sudden change of temperature or humidity. Turn off the power, then turn it on a few hours later.
- ⇒ The disc does not allow the operation, or an unplayable disc is inserted. Check and replace the disc.

Picture

Picture is noisy.

- ⇒ The player is connected to a VCR directly and the copyguard function is activated. Connect the player so that the picture signal flows directly to the TV.
- ⇒ With some discs, the picture may be blurred when PIC MODE is set to FILM or AUTO. Set PIC MODE to VIDEO or SUPER SMART.

Picture is distorted when using COMPONENT VIDEO OUT or S-VIDEO output jack(s).

- ⇒ The Progressive scanning mode is activated. Change the scanning mode to the Interlaced scanning mode by selecting VIDEO OUTPUT in PREFERENCE SETUP as SVIDEO or YCBCR.

Karaoke

No microphone signal can be found in the audio.

- ⇒ Connect the downmix L/R outputs of the player to your sound system. Digital audio connection does not carry microphone signals.

No graphics come out when playing Super CD+G.

- ⇒ When selecting a song after a rest, insert a song number and wait for the display of title before pressing ENTER or PLAY.

Key control does not work.

- ⇒ Press MIC ON to turn on the KARAOKE MODE.

AVI/MP3/JPEG

No sound and / or no picture comes out.

- ⇒ AVI/MP3 disc is recorded with the "packet writing (UDF format)." It cannot be played.
- ⇒ Check the files you want to play back.

Files (tracks) are not played in the recorded order.

- ⇒ This player plays the files in the alphabetic order. So, the playback order can vary.

AVI files cannot be played back.

- ⇒ The format of the file is not asf.

AVI files are played back without sound.

- ⇒ This player can play back the MP3 sound for the audio part of the AVI files. Select the proper audio CODEC when making AVI files.

Specifications

Specifications and appearance are subject to change without prior notice.

General

Optical discs	DVD, Video CD, Super CD+G, INX, INX2, CD+G, Audio CD, HDCD AVI, MP3, JPEG DVD±R, DVD±R DL, DVD-RW, CD-R/RW
USB memory devices	AVI, MP3, JPEG, CD+G (MP3+MCG), CD+G (MP3G) Hard drive, Memory stick (FAT32)
Video format	NTSC/PAL, 480i (Interlaced scan) / 480p (Progressive scan)

Other

Power requirements	AC 110 - 240V 50/60Hz
Power consumption	10W (POWER ON), 1.1W (STANDBY mode)
Mass	3.2kg (7.2 lbs)
Dimensions (W×H×D)	430mm×57mm×246mm (17 inch×2-1/4 inch×9-3/4 inch)

Video outputs

COMPONENT (pin jacks)	Y Output: 1.0 Vp-p (75 Ω) P _B /P _R Output: 0.7 Vp-p (75 Ω)
VIDEO OUT (pin jack)	1.0 Vp-p (75 Ω)
S-VIDEO OUT (S jack)	Y Output: 1.0 Vp-p (75 Ω) C Output: 286 mVp-p (75 Ω)
Horizontal resolution 500 lines or more	

Audio outputs

ANALOG OUT (pin jack)	2.0 Vrms (10 k Ω)
DIGITAL OUT (COAXIAL)	0.5 Vp-p (75 Ω termination)
DIGITAL OUT (OPTICAL)	-21 dBm to -15 dBm (peak)

Audio characteristics

Frequency response	CD (sampling frequency 44.1 kHz): - 2 Hz to 20 kHz DVD (sampling frequency 48 kHz): - 2 Hz to 22 kHz (4 Hz to 20 kHz for DTS and Dolby Digital bitstream signals) DVD (sampling frequency 96 kHz): - 2 Hz to 44 kHz
Dynamic range	16 bit: More than 98 dB 20 bit/24 bit: More than 100 dB
Wow and flutter	Unmeasurable (less than ± 0.002%)
Total harmonic distortion	Less than 0.007%

CAVS

LIMITED WARRANTY

CAVS DVD KARAOKE

CAVS USA Inc. warrants this product and all parts thereof, except as set forth below ONLY TO THE ORIGINAL PURCHASER AT RETAIL to be FREE FROM DEFECTIVE MATERIALS AND WORKMANSHIP from the data of original retail purchase for the period as shown below. ("The Warranty Period")

PARTS	LABOR
1 YR	90 DAYS

THIS LIMITED WARRANTY IS VALID ONLY IN THE FIFTY (50) UNITED STATES, THE DISTRICT OF COLUMBIA AND IN COMMONWEALTH OF PUERTO RICO.

WHAT WE WILL DO :

If this products is found to be defective, CAVS will repair or replace defective parts at no charge to the original owner. Such repair and replacement services shall be rendered by CAVS during normal business hours at CAVS authorized service centers. Parts used for replacement are warranted only for the remainder of the Warranty Period. All products and parts there of may be brought to a CAVS authorized service center on a carry-in basis.

WHAT YOU MUST DO FOR WARRANTY SERVICE :

Return your product to a CAVS authorized service center with a copy of your bill of sale. For your nearest CAVS authorized service center, please call : (562) 777-1846.

If service is not available locally, box the product carefully, preferably in the original carton, and ship, insured, with a copy of your bill of sale plus a letter of explanation of the problem to the nearest CAVS Factory Service Center, the name and location of which will be given to you by the phone.

If you have any questions concerning your CAVS Product, please contact our Technical Support Department.

WHAT IS NOT COVERED :

This limited warranty provided by CAVS does not cover :

1. Products which have been subject to abuse, accident, alteration, modification, tampering, negligence, misuse, faulty installation, lack of reasonable care, or if repaired or serviced by anyone other than a service facility authorized by CAVS to render such service, or if affixed any attachment not provided with the products, or if the model number or serial number has been altered, tampered with, defaced or removed ;
2. Initial installation and removal for repair ;
3. Operational adjustments covered in the Owner's Manual, normal maintenance, video and audio head cleaning ;
4. Damage that occurs in shipment, due to act of God, and cosmetic damage ;
5. Signal reception problems and failures due to line power surge ;
6. Video Pick-up, Tubes/CCD Image Sensor, Cartridge, Stylus (Needle) are covered for 90 days from the data of purchase ;
7. Accessories ;
8. Batteries (except that Rechargeable Batteries are covered for 90 days from the date of purchase) ;

There are no express warranties except as listed above.

THE DURATION OF ANY IMPLIED WARRANTIES, INCLUDING THE IMPLIED WARRANTY OF MERCHANTABILITY, IS LIMITED TO THE DURATION OF THE EXPRESS WARRANTY HEREIN.

CAVS SHALL NOT BE LIABLE FOR THE LOSS OF USE OF THE PRODUCT, INCONVENIENCE, LOSS OR ANY OTHER DAMAGES, WHETHER DIRECT, INCIDENTAL OR CONSEQUENTIAL (INCLUDING, WITHOUT LIMITATION, DAMAGE TO TAPES, RECORDS OR DISCS) RESULTING FROM THE USE OF THIS PRODUCT, OR ARISING OUT OF ANY BREACH OF THIS WARRANTY. ALL EXPRESS AND IMPLIED WARRANTIES, INCLUDING THE WARRANTIES OD MERCHANT-ABILITY AND FITNESS FOR PARTICULAR PURPOSE, ARE LIMITED TO THE WARRANTY PERIOD SET FORTH ABOVE.

Some states do not allow the exclusion of incidental or consequential damages or limitations on how long an implied warranty lasts, so these limitations or exclusions may not apply to you. This warranty gives you specific legal rights and you may also have other rights which vary from state to state.

CAVS USA Inc.

10707 Fulton Wells Ave
Santa Fe Springs, CA 90670

REFURBISHED PRODUCTS CARRY A SEPARATE WARRANTY, THIS WARRANTY DOES NOT APPLY. FOR DETAILS OF REFURBISHED PRODUCT WARRANTY, PLEASE REFER TO THE REFURBISHED PRODUCT WARRANTY INFORMATION PACKAGED WITH EACH REFURBISHED PRODUCT.

For customer use :

Enter below the Model No. which is located either on the rear, bottom or side of the cabinet. Retain this information for future reference.

Model No. :

Serial No. :

Purchase data :

Name of dealer :

Authorized Service Centers



HOW TO LOCATE YOUR CAVS SERVICE CENTER

CALL: 1 (562) 777-1846
<http://www.cavsusa.com>

Dear Customer,

In order to receive the most satisfaction from your purchase, please read the instruction booklet before operating the unit. In the event that repairs are necessary, please call 1 (562) 777-1846 for your nearest authorized service or visit our website www.cavs.com. Remember to retain your Bill of Sale for Warranty Service.

Do not service the product yourself

Caution

To prevent electrical shock, do not open the cabinet. There are no user serviceable parts inside. Please refer to qualified service personnel for repairs.

Accessories

To purchase accessories for your CAVS product, please call : 1 (562) 777-1850 or visit us at www.cavsusa.com

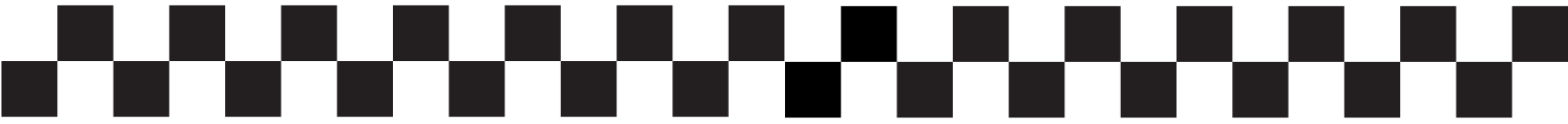

CAVS USA INC.

10707 Fulton Wells Ave
Santa Fe Springs, CA 90670

TEL: 1 (562) 777-1846
<http://www.cavsusa.com>

